

CIRCUIT CORRESPONDS TO PCB 'B'

(J) - 80-90V (K) - 0.6V (L) - 125V (M) - 0.8V

MODEL	SERIES 500
CIRCUIT	PHONO SECTION
DRW NO	2
DATE	26/9/89

Audio Innovations

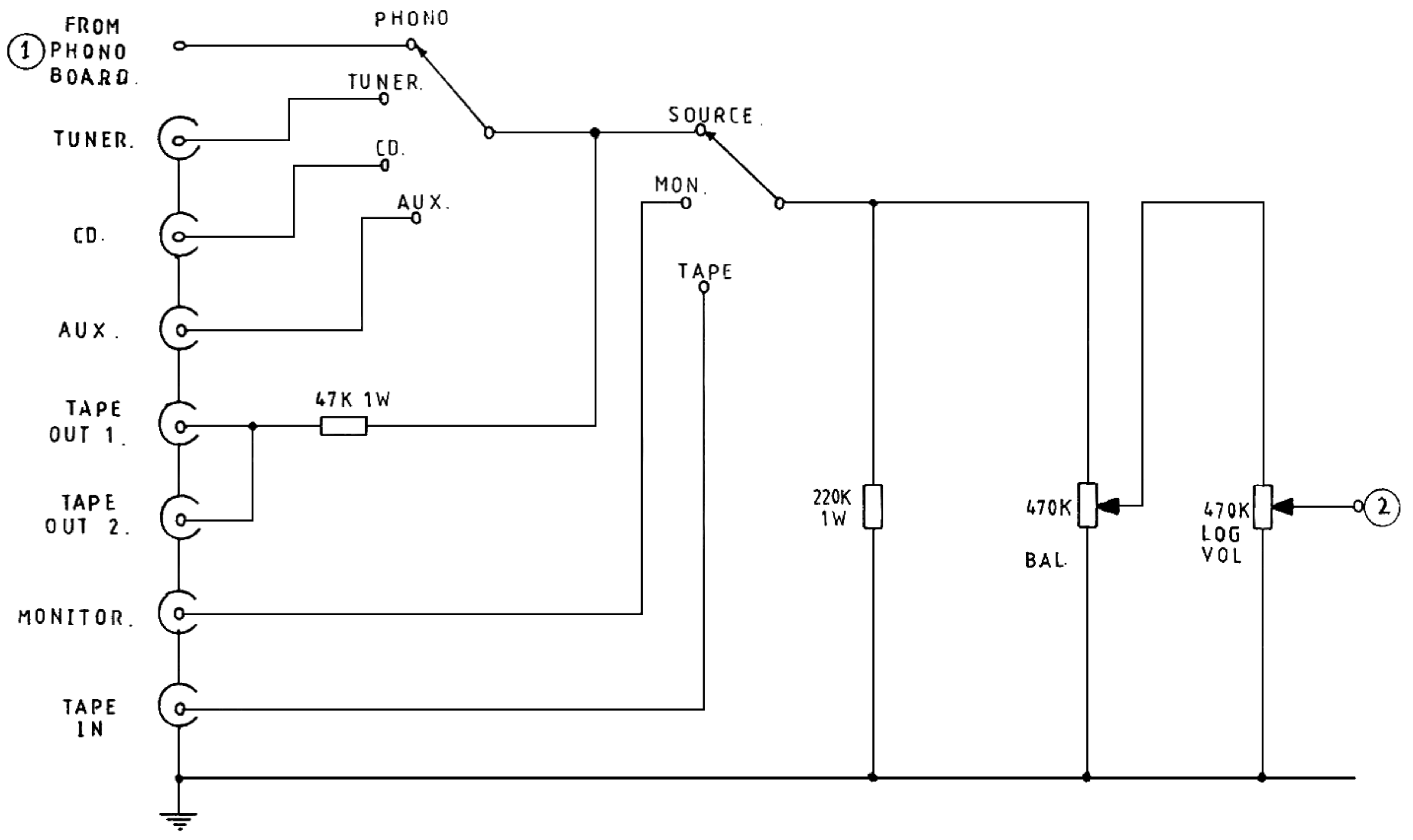

NOTE INPUT SOCKETS ARE NOT DRAWN IN ORDER ONE CHANNEL SHOWN.

MODEL	SERIES 500.		
CIRCUIT	SWITCHING.		
DRW NO	2	DATE	26/9/89

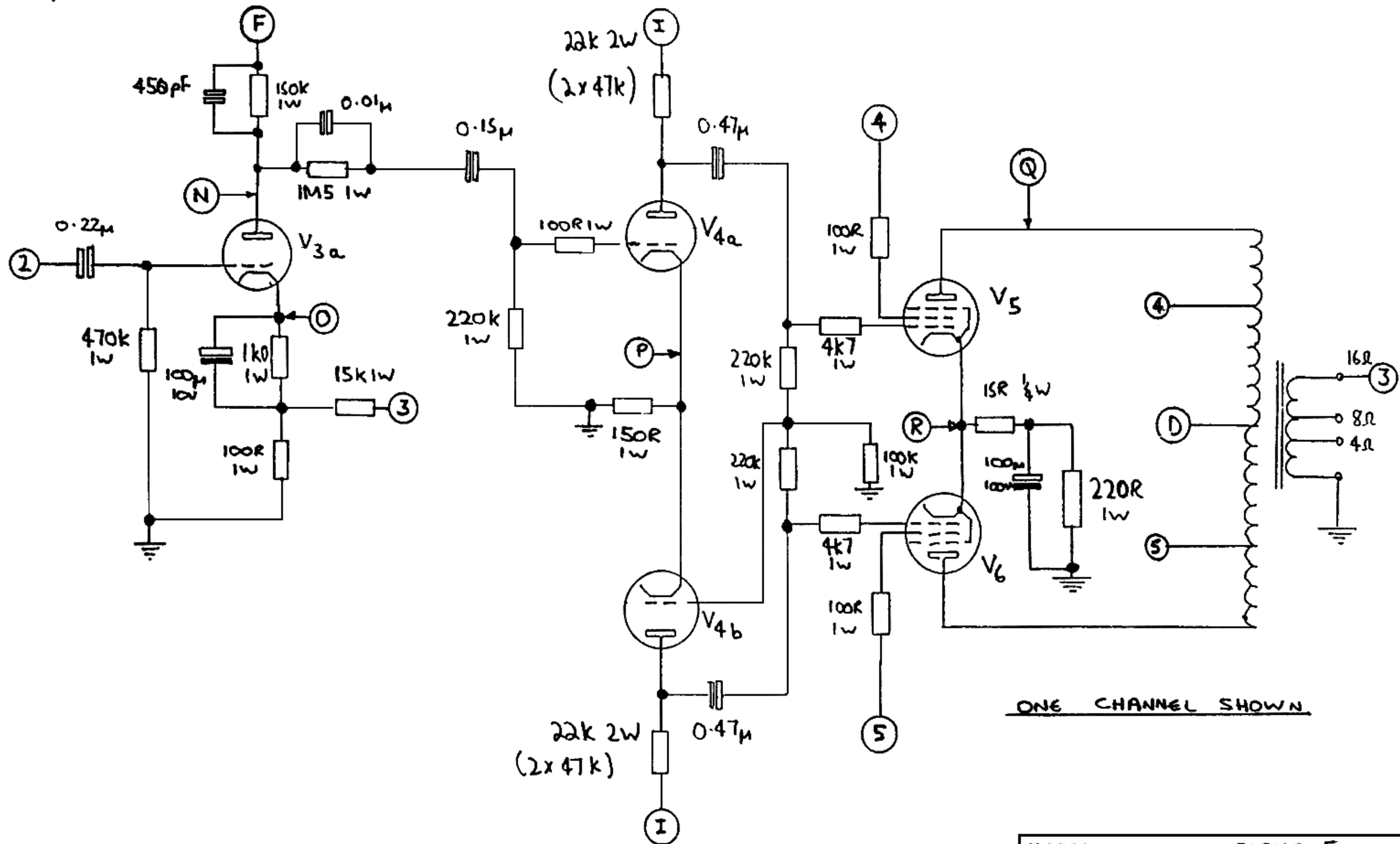

(N) - 150V (O) - 1V (P) - 1.8V (Q) - 380V (R) - 28V

MODEL	SERIES 500
CIRCUIT	POWER AMP
DRW NO 2	DATE 26/9/89

Audio Innovations
 F1 - 100V-120V T6-3A
 220V-240V T5-15A

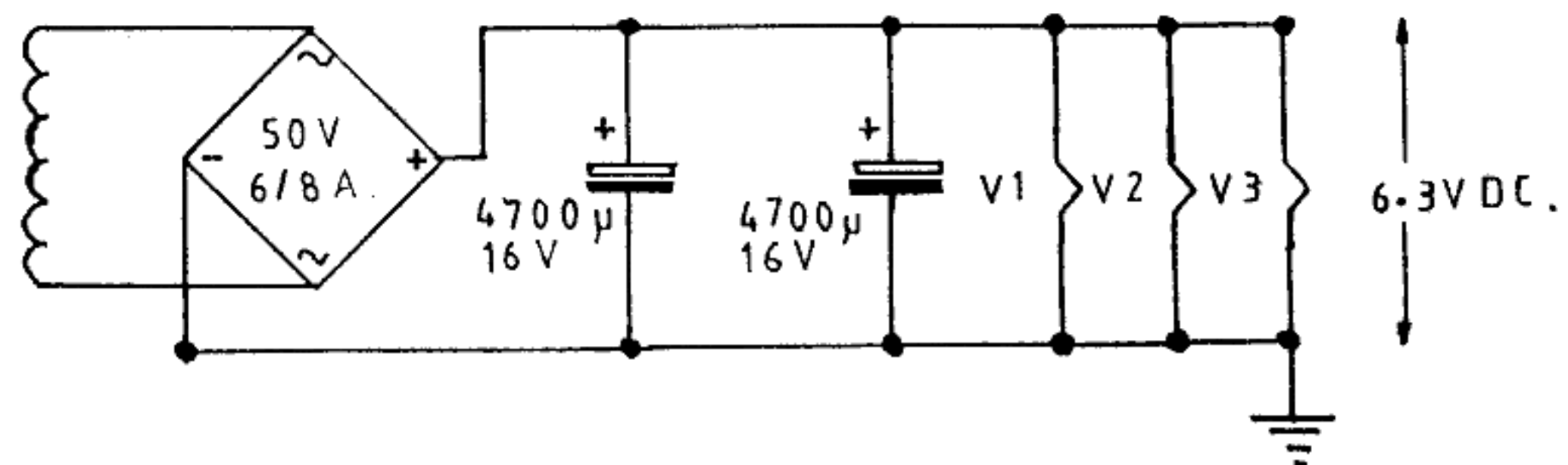
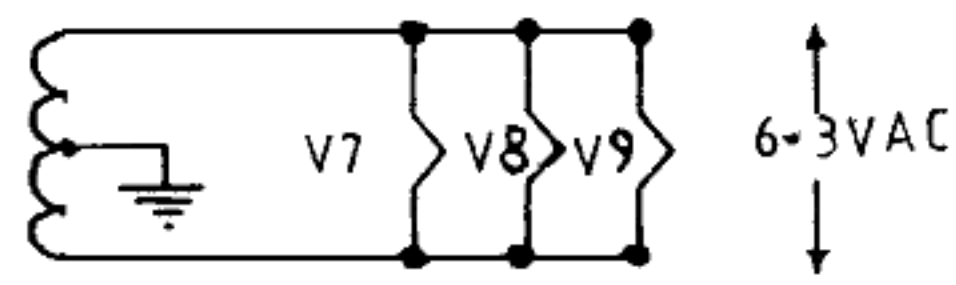
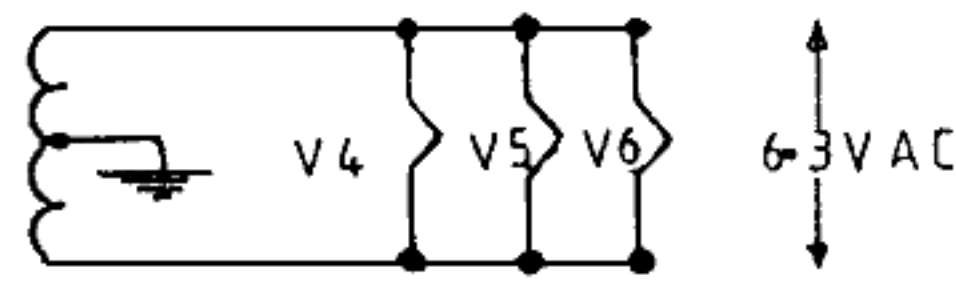
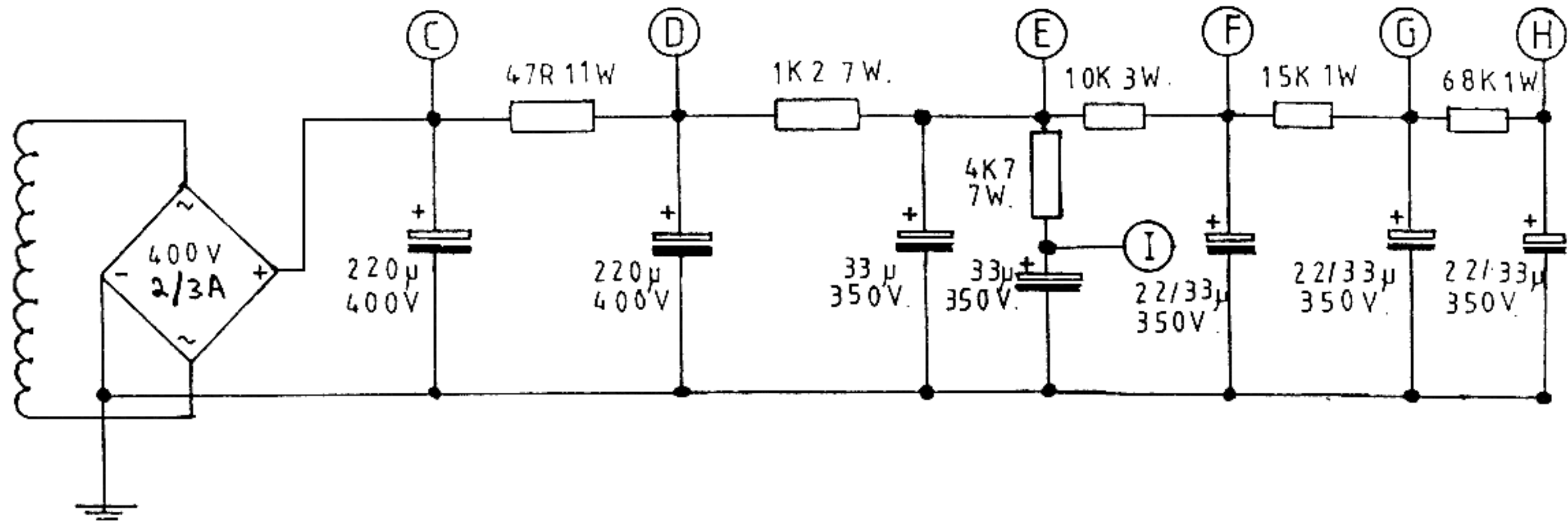
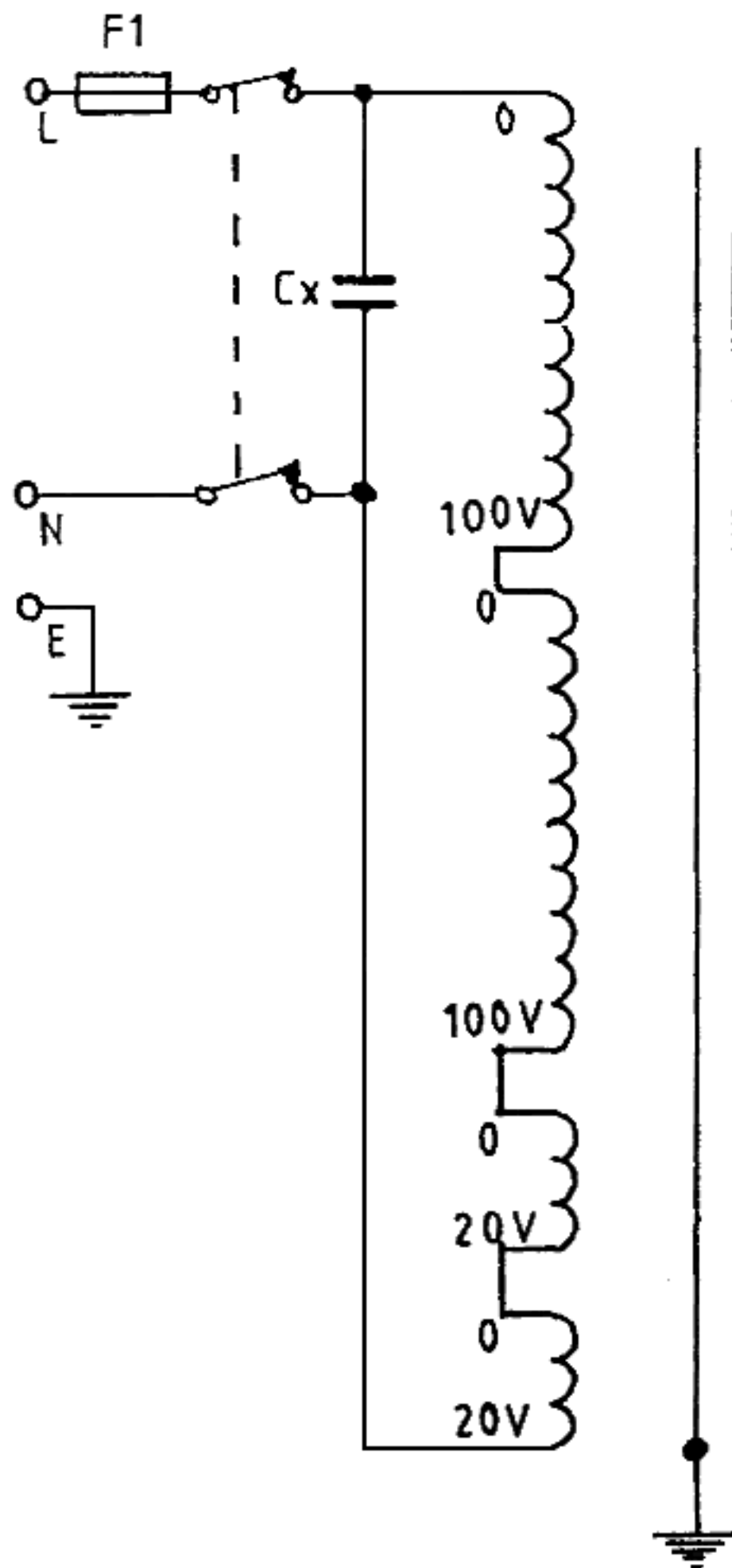

- ⓐ — 390V
- ⓓ — 380V
- ⓔ — 350V
- ⓕ — 300V
- ⓖ — 255V
- ⓗ — 175V
- ⓘ — 235V

- V₁ - ECC83
- V₂ - ECC83
- V₃ - ECC83
- V₄ - PCC88
- V₅ - EL34
- V₆ - EL34
- V₇ - PCC88
- V₈ - EL34
- V₉ - EL34

} OPPOSITE CHANNEL.

MODEL	SERIES 500.
CIRCUIT	POWER SUPPLY.
DRW NO 2	DATE 26/9/89